



ARCHITECTURAL  
GRATES + DRAINS



# SDiPS

## Slot Drain



This is a Punched Slot Stainless Steel Gate component to fit the Slot Drain SD90

This is the newest addition to the original Slot Drain.

Please be aware that depending on the installation environment, for a pool installation or close to a surf beach, you may need to have your stainless steel grates electropolished.

### SPECIFICATIONS + DIMENSIONS

Channel Width	30mm
Channel Depth	Adjustable
Length(s)	1000mm 1500mm
Outlet Size	N/A

**Code** SDiPS  
**Range** Slot Drain  
**Grate Style** PS  
**Category** Components  
**Steel Grade** 316

### STORMTECH COLOUR FINISHES

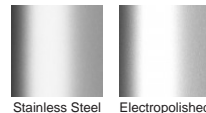

Electroplate finishes subject to natural variation with time and local environment. Factors such as pools/surf beaches may require electropolishing. Contact us for suitability.

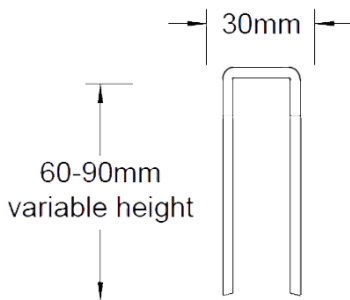

### PRODUCT APPLICATIONS

- Balcony Drainage
- Commercial Drainage
- Courtyard / Patio Drainage
- Driveway Drainage
- Pool and Spa Area Drainage
- Paved Area Drainage
- Special Needs Drainage

Grates longer than 1500mm supplied in sections. Tile Inserts longer than 1200mm supplied in sections. Channels over 3000mm supplied in sections with joiner. +/-2mm tolerance on dimensions.

Copyright © Stormtech Pty Ltd. Patent 733361. Drawings not to scale, please use dimensions shown. Downloaded 08/06/2026 (please check for updates)



Visit [stormtech.com.au](http://stormtech.com.au)  
for tools + inspiration.

Phone **1300 653 403**

Email [info@stormtech.com.au](mailto:info@stormtech.com.au)